

Agilent E4438C ESG Vector Signal Generator

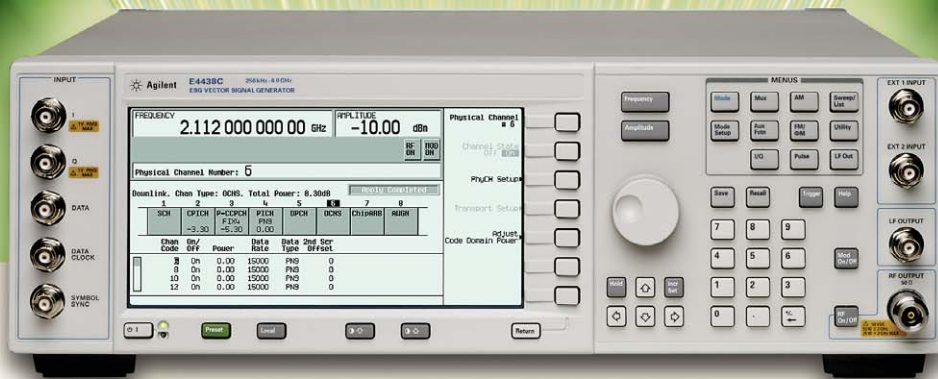



The E4438C ESG vector signal generator ...

Agilent's E4438C ESG vector signal generator combines outstanding RF performance and sophisticated baseband generation to deliver calibrated test signals at baseband, IF, and RF frequencies up to 6 GHz. Offering an internal baseband generator with arbitrary waveform and real-time I/Q capabilities, ample waveform playback and storage memory, and a wide RF modulation bandwidth, the E4438C ESG is equipped to test today's complex wireless systems and their components.

Baseband Generation and Signal Creation

- Internal baseband generator with 80 MHz RF BW and arbitrary waveform and real-time I/Q generation
- Up to 160 MHz RF BW using external I/Q inputs
- 64 Msa waveform memory allows playback of complete test scenarios without rebuilding waveforms
- 1 Gsa of non-volatile memory for storing waveforms and instrument states
- Create reference signals for LTE, WiMAX™, WLAN, W-CDMA, cdma2000®, GSM, DVB, and more with Signal Studio software
- Digital I/O, fading, and PC waveform streaming with Baseband Studio products

Automation and Communication Interface

- 10BaseT LAN and GPIB
- SCPI and IVI-COM drivers
- Backwards compatible with all ESG signal generators

Signal Characteristics

- 250 kHz to 1, 2, 3, 4, or 6 GHz
- +17 dBm output power
- -134 dBc/Hz phase noise

Modulation and Sweep

- AM, FM, Φ M, and pulse
- ASK, FSK, MSK, PSK, QAM, and custom I/Q
- Step and list for frequency and power

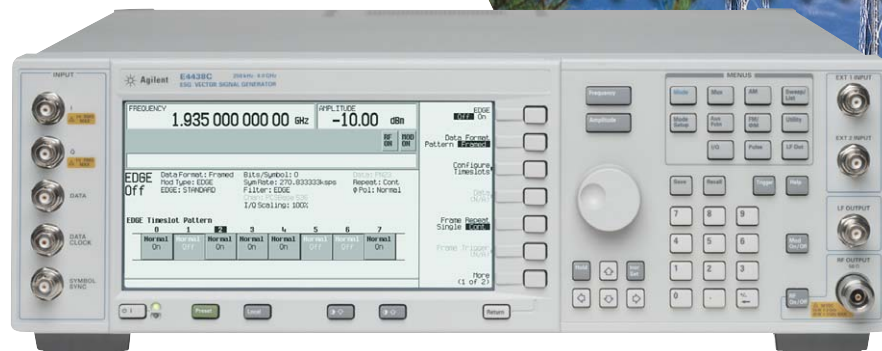
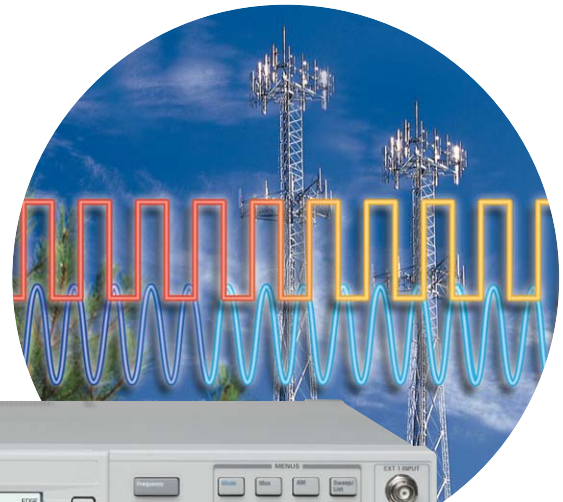

www.agilent.com/find/esg

... RF performance and leading edge baseband generation

Typical SSB phase noise (Option UNJ) at $f_c = 850$ MHz

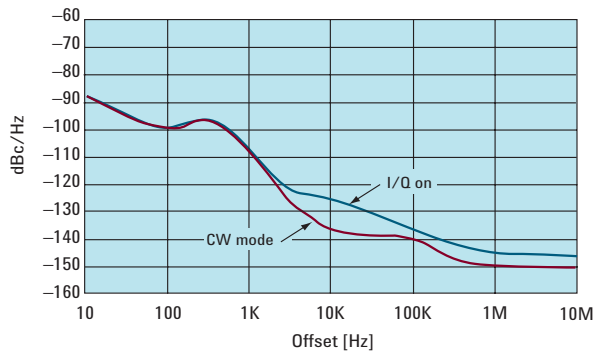

Typical level accuracy

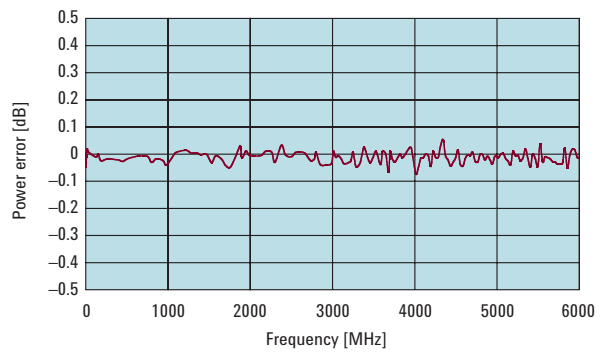

Typical I/Q modulation bandwidth

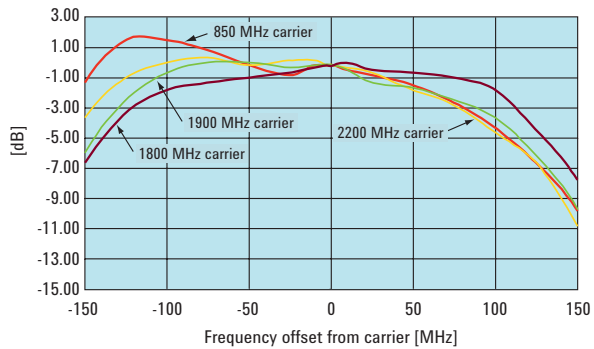

Typical maximum power performance

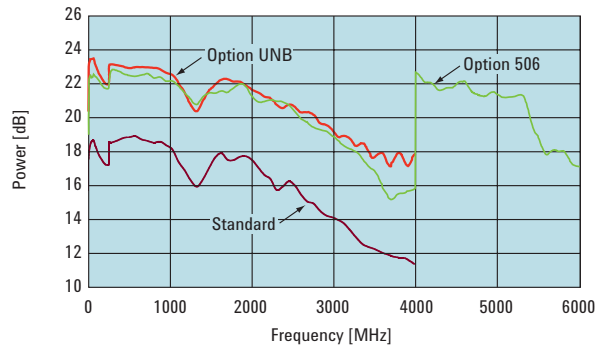

Specification summary

Frequency range	250 kHz to 1, 2, 3, 4, or 6 GHz
Frequency switching speed	< 9 ms in CW mode
Output power, typical	+17 dBm at 1 GHz
Level accuracy	± 0.5 dB, up to 2 GHz
Amplitude switching speed	< 15 ms in CW mode
Phase noise, typical (Option UNJ)	< -134 dBc/Hz at 20 kHz offset, 1 GHz carrier frequency
RF modulation bandwidth	160 MHz using external I/Q inputs 80 MHz using internal baseband generator
Baseband memory	8 or 64 Msamples (40 or 320 Mbytes)
Baseband sample rate	Up to 100 Msamples/s
Non-volatile waveform storage	1.2 Gsamples (6 GBytes)
Connectivity	10BaseT LAN, GPIB, RS-232

Modulation types and supported standards

- 3GPP W-CDMA
- 3GPP LTE
- HSUPA
- HSDPA
- HSPA+
- TD-SCDMA
- cdmaOne
- cdma2000
- 1xEV-DO
- GSM/EDGE/EGPRS2 (EDGE Evolution)
- 802.11a/b/g/p/j/n WLAN
- 802.16e Mobile WiMAX
- 802.16d Fixed WiMAX
- Bluetooth™
- DVB-T/H/C/S
- ATSC
- ISDB-T
- DTMB
- S-DMB
- T-DMB
- FM stereo/RDS/RBDS
- FM
- AM
- Φ M
- Pulse
- ASK
- PSK
- MSK
- FSK
- QAM
- Pulse building
- Multi-satellite GPS
- Multitone distortion
- Noise Power Ratio



Test MIMO receivers with up to Mx4 configurations

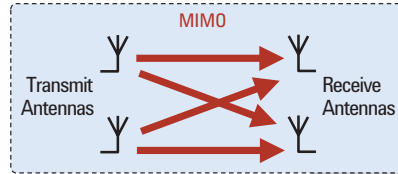

- Create MIMO test signals using multiple ESGs and Signal Studio software
- Set up time is reduced because Signal Studio software synchronizes waveform playback for multiple signal generators
- Add more precise baseband synchronization (Option HEC) or RF phase coherency (Option HCC, HBC)
- Reduce early development costs for basic receiver test by using Signal Studio waveforms with embedded fading

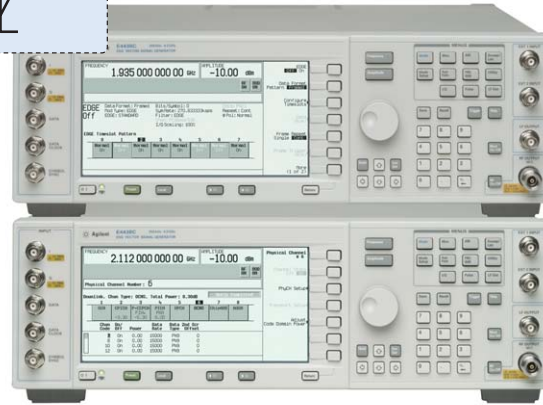

Signal Studio for 802.16 WiMAX

- Fully supports mobile WiMAX MIMO signal generation:
 - Two antennas STC/MIMO (Matrix A/B) in DL-PUSC
 - Collaborative Spatial Multiplexing (SM) in UL-PUSC
 - Fading emulation in waveform with static multi-path and mobile SISO and MIMO channel models, and dual 1x2 MIMO fading for UL collaborative SM

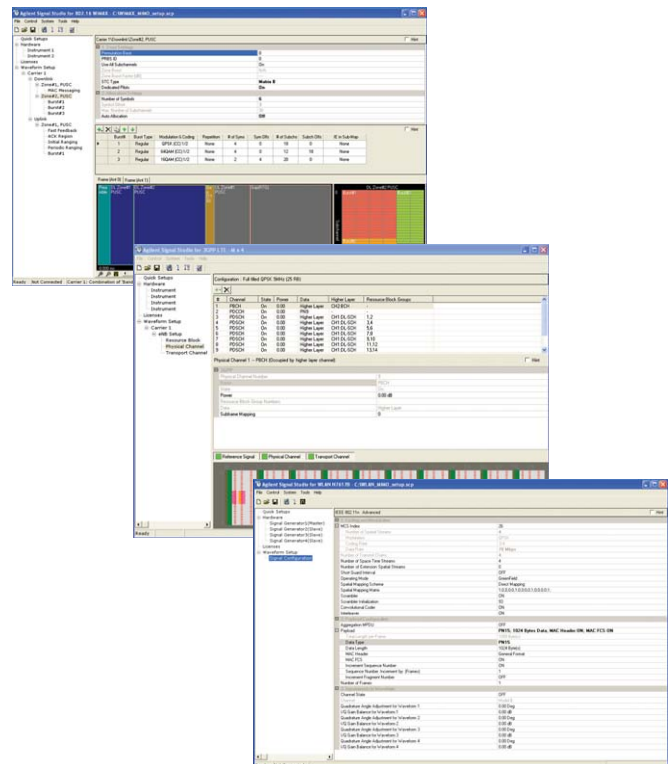

Signal Studio for 3GPP LTE

- 2x2, 4x4 spatial multiplexing with CDD
- 2x1, 4x1 transmit diversity
- Fading emulation in waveforms, with static multi-path

Signal Studio for 802.11 WLAN

- Supports multiple 802.11n MIMO configurations: 2x2, 2x3, 2x4, 3x3, 3x4 and 4x4
- Fading emulation in waveform with static multi-path and channel models A to F for MIMO

www.agilent.com/find/esg

Built for receiver test with flexible channel coding for bit error rate testing

Focused applications for receiver testing

- Generate a continuous, real-time stream of frames with fully-coded channels
- Verify baseband coding algorithms
- Full control over frame structure
 - Generate standards-based waveforms
 - Easily synchronize to base stations or mobile handsets
 - Modify frame structure to suit your test needs
 - Select data sources: pseudorandom sequences or user generated data
- Supports multiple communications formats
 - 3GPP W-CDMA
 - 3GPP LTE
 - HSUPA
 - HSDPA
 - HSPA+
 - TD-SCDMA
 - cdmaOne
 - cdma2000
 - 1xEV-DO
 - GSM/EDGE/EGPRS2 (EDGE Evolution)
 - 802.11a/b/g/p/j/n WLAN
 - 802.16e Mobile WiMAX
 - 802.16d Fixed WiMAX
 - *Bluetooth*
- Simulate real world scenarios for multi-satellite GPS
- Create FSK, PSK, MSK, QAM and custom I/Q modulation formats

Calibrated noise personality

- Generate AWGN
- Truly uncorrelated real-time noise signal with variable bandwidth up to 80 MHz
- Set E_b/N_o or C/N within the W-CDMA and cdma2000 personalities
- Generate a repeated noise waveform to debug receiver susceptibility issues

Perform bit error rate tests

- Supports data rates up to 60 Mbps
- Analyze PN9, PN11, PN15, PN20, and PN23 data sequences
- Accommodating connectivity: 5V CMOS, 3V CMOS, TTL, or 75 Ω



The ESG vector signal generator is ready ...

Applications for component and receiver test, and R&D

- 3GPP W-CDMA
- 3GPP LTE
- HSUPA
- HSDPA
- HSPA+
- TD-SCDMA
- cdmaOne
- cdma2000
- 1xEV-DO
- GSM/EDGE/EGPRS2 (EDGE Evolution)
- 802.11a/b/g/p/j/n WLAN
- 802.16e Mobile WiMAX
- 802.16d Fixed WiMAX
- *Bluetooth*
- Multi-satellite GPS
- AWGN
- Custom modulation
- Multitone distortion

MIMO configurations for

- 3GPP LTE
- 802.16e Mobile WiMAX
- 802.11n WLAN

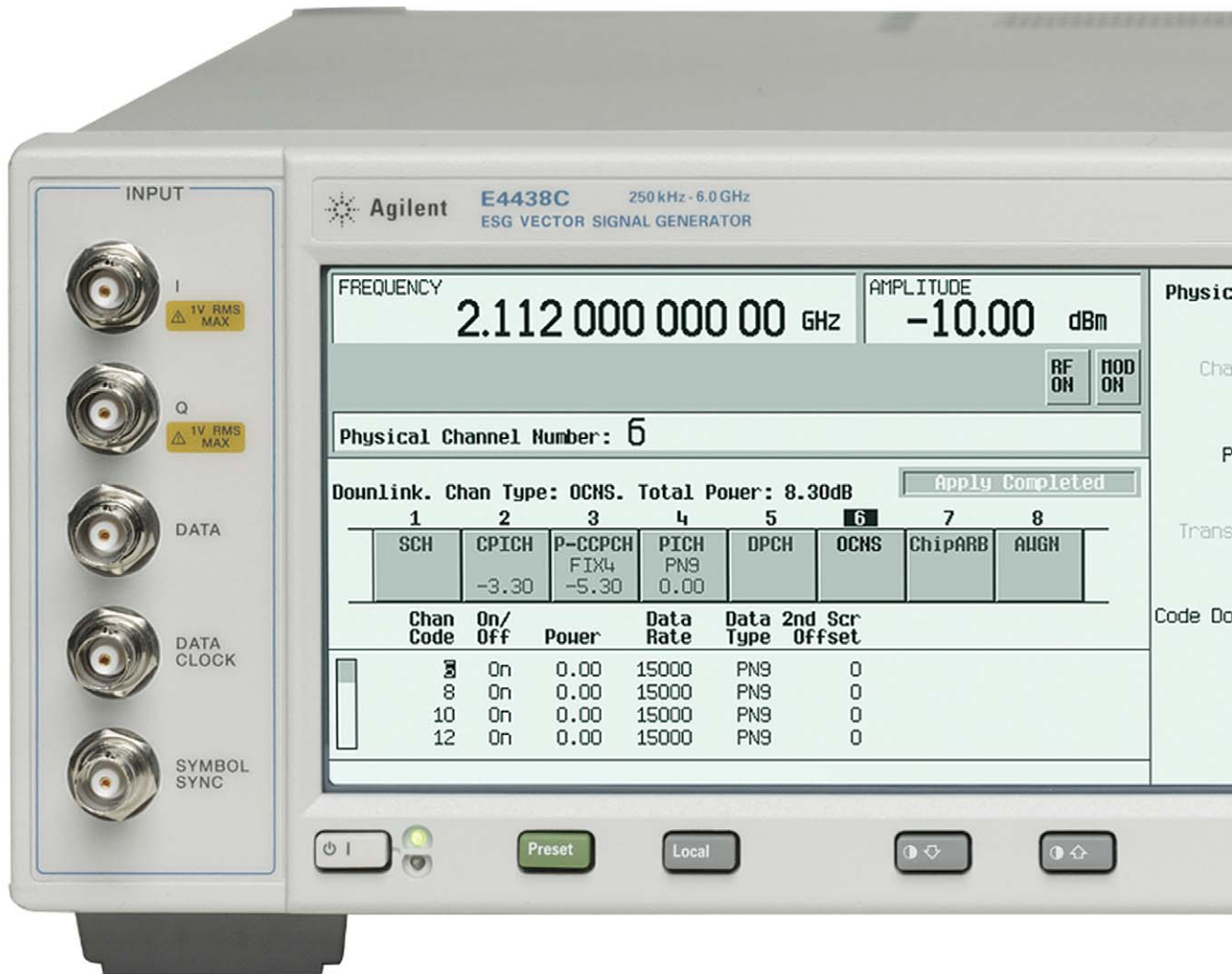

www.agilent.com/find/esg

... to meet your test requirements

Powerful standard features

- Excellent spectral purity
- Electronic attenuator
- Simple softkey menu structure allows access to sophisticated features
- Built-in help
- Differential and single-ended I/Q outputs
- Suite of I/Q adjustments: gain, DC offsets, quadrature skew
- Save and recall instrument settings
- IntuiLink software allows easy data exchange from Microsoft® applications
- 10BaseT LAN

Superior dual mode baseband generator

- Dual mode capability supports both waveform playback and real-time signal generation
- 80 MHz RF modulation bandwidth
- 64 Msamples (320 Mbytes) of waveform playback memory
- Generate waveforms at up to 100 Msamples/s
- Hardware resampling technology eliminates need for multiple reconstruction filters
- 16-bit DAC for improved dynamic range
- Flexible baseband reference clock 250 kHz to 100 MHz
- Industry standard filters or user-definable FIR filters
- Set E_b/N_0 or C/N ratio for W-CDMA and cdma2000
- Generate AWGN with up to 80 MHz bandwidth



www.agilent.com/find/esg



Connectivity for your demanding test applications

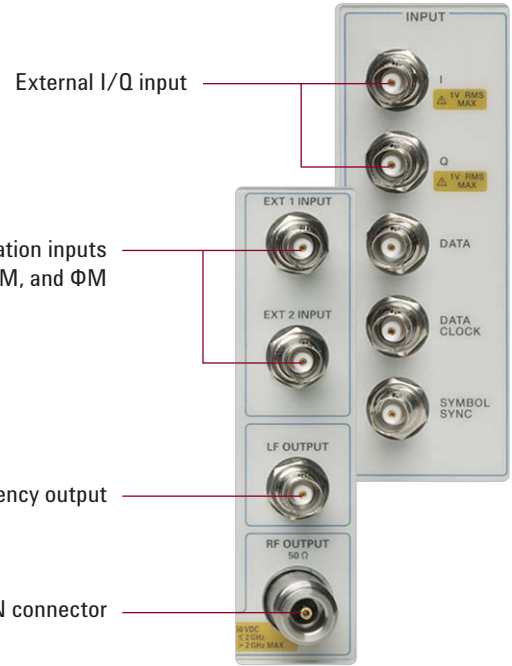
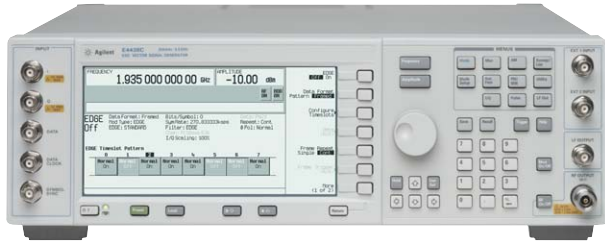

Digital bus interface
Wide array of input and output timing signals including markers
Coherent carrier output

BERT

Differential and single-ended I/Q outputs

External baseband reference

External frequency reference

Trigger signals

10BaseT LAN interface

RS-232 interface

GPIB interface

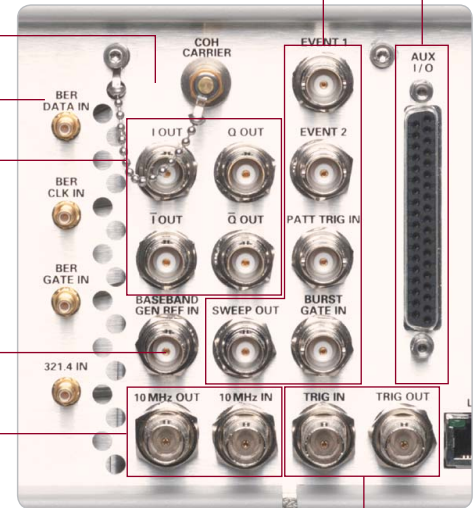

www.agilent.com/find/esg

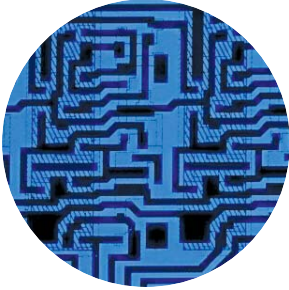

Create Agilent validated and performance optimized reference signals ...

Signal Studio

Agilent Signal Studio is a suite of flexible, easy-to-use, PC-based signal creation software that will cut the time you spend on signal simulation. Signal Studio provides an Agilent validated and performance optimized reference signal to better characterize, evaluate, and fine tune your designs under parametric and functional test conditions.

Signal Studio complements the general-purpose capabilities of the ESG and offers a cost-effective means of tailoring the signal generator to your application-specific design, development, and production test needs for modern radio transceivers and the components that comprise them. And, with a demonstrated first-to-market track record, Agilent's Signal Studio continues to help you stay at the forefront of product development as wireless systems continue to evolve. More information www.agilent.com/find/signalstudio



Mobile Communications



3GPP W-DCMA
 HSUPA/HSDPA
 HSPA+
 3GPP LTE
 TD-SCDMA
 cdmaOne
 cdma2000®
 1xEV-DO
 GSM/EDGE/EGPRS2
 (EDGE Evolution)

Wireless Connectivity



802.11 WLAN (a/b/g/p/j/n)
 802.16e Mobile WiMAX™
 802.16d Fixed WiMAX™
 Bluetooth™
 802.15 MB-OFDM UWB

Audio/Video Broadcasting



DVB-T/H/C/S
 ATSC
 ISDB-T
 DTMB
 T-DMB
 FM/RDS

Detection, Positioning, Tracking, & Navigation



Pulse Building
 Multi-satellite GPS

General RF & Microwave



Toolkit
 Enhanced Multitone
 Noise Power Ratio

www.agilent.com/find/esg



Agilent service and support

Providing greater certainty with services...

The ease-of-use and performance of the E4438C ESG vector signal generator is only a small part of what is available from Agilent Technologies. Agilent's ability to understand your business needs and quickly provide the latest end-to-end service and support solution gives you the certainty and confidence to accelerate the development and deployment of winning technologies for you and your customers.

Support solutions

Agilent's support solutions can help you get more from your ESG vector signal generator as well as your other test equipment by increasing productivity and maximizing uptime. Our programs are designed with flexibility and can be tailored to meet your needs, including billing and response times.

Calibration services

You can choose return-to-Agilent or on-site service. And, the service can be ordered as needed or on a regularly scheduled basis. Consider our up-front calibration plans when you are purchasing your new ESG vector signal generator. These services provide you with significant savings over per-incident charges and the measurement confidence you need to achieve your business goals.

Repair services

Ensure your instrument is up and running as quickly as possible. The ESG vector signal generator comes with a return-to-Agilent warranty. Additional repair options are available at the time of purchase such as a 3- or 5-year plan.

Knowledge services

Our goal at Agilent is to provide you with the key resources that will help you build the comprehensive solutions that keep you competitive. Agilent's knowledge services are the industry's most reputable, and encompass a wide range of solutions designed with you in mind.

Test instrument consulting

Agilent provides you with the technical expertise to complete and implement your test strategies in your R&D or manufacturing application.

Process consulting

Agilent's experts help you integrate new R&D or manufacturing test processes and technology into your current environment.

Training and education

Encompassing technology training, product training, measurement fundamentals and applications training, our classes can be delivered on-site or at an Agilent Training Center.

For more information on Agilent education and training visit: www.agilent.com/find/education

Simplified ordering structure for the E4438C ESG vector signal generator

Frequency options

- 501 250 kHz to 1 GHz
- 502 250 kHz to 2 GHz
- 503 250 kHz to 3 GHz
- 504 250 kHz to 4 GHz
- 506 250 kHz to 6 GHz

Hardware options

- 601 Internal baseband generator (8 Msamples memory)
- 602 Internal baseband generator (64 Msamples memory)
- 005 6 Gbyte non-volatile waveform storage
- UNB High output power with mechanical attenuator
- UNJ Enhanced phase noise performance
- 1E5 High-stability time base
- UN7 Internal bit-error-rate analyzer
- 300 GSM/EDGE basestation loopback BER test capability
- 1EM Move all front panel connectors to rear
- HEC External clock input for internal baseband generator
- HCC Rear panel connections for use with distribution networks for phase coherency applications (250 MHz to 4 GHz)
- HBC Rear panel connections for use with distribution networks for phase coherency applications (4 GHz to 6 GHz)

Signal Studio and embedded software

- 400 3GPP W-CDMA FDD
- 401 cdma2000 and IS-95-A
- 402 TDMA (GSM, GPRS, EDGE, EGPRS, NADC, PDC, PHS, TETRA, DECT)
- 403 Calibrated noise
- 407 Signal Studio for S-DMB
- 409 Multi-satellite Global Positioning System (GPS)
- 419 Signal Studio for 3GPP W-CDMA HSPA
- N7600B Signal Studio for 3GPP W-CDMA FDD
- N7601B Signal Studio for 3GPP2 CDMA
- N7602B Signal Studio for GSM/EDGE
- N7606B Signal Studio for *Bluetooth*
- N7611B Signal Studio for Broadcast Radio
- N7612B Signal Studio for TD-SCDMA
- N7613A Signal Studio for 802.16-2004 (WiMAX)
- N7615B Signal Studio for 802.16 WiMAX
- N7616B Signal Studio for T-DMB
- N7617B Signal Studio for 802.11 WLAN
- N7620A Signal Studio for Pulse Building
- N7621B Signal Studio for Multitone Distortion
- N7623B Signal Studio for Digital Video
- N7624B Signal Studio for 3GPP LTE



www.agilent.com/find/esg

Product literature

E4438C ESG vector signal generator platform

- *E4438C ESG Vector Signal Generator*, Data Sheet, literature number 5988-4093EN.
- *E4438C ESG Vector Signal Generator*, Configuration Guide, literature number 5988-4085EN.
- *Signal Studio software*, Brochure, literature number 5989-6448EN.

www.agilent.com

For more information on Agilent Technologies' products, applications or services, please contact your local Agilent office. The complete list is available at:

www.agilent.com/find/contactus

Remove all doubt

Our repair and calibration services will get your equipment back to you, performing like new, when promised. You will get full value out of your Agilent equipment throughout its lifetime. Your equipment will be serviced by Agilent-trained technicians using the latest factory calibration procedures, automated repair diagnostics and genuine parts. You will always have the utmost confidence in your measurements.

Agilent offers a wide range of additional expert test and measurement services for your equipment, including initial start-up assistance, onsite education and training, as well as design, system integration, and project management.

For more information on repair and calibration services, go to:

www.agilent.com/find/removealldoubt



Agilent Email Updates

www.agilent.com/find/emailupdates

Get the latest information on the products and applications you select.



Agilent Direct

www.agilent.com/find/agilentdirect

Quickly choose and use your test equipment solutions with confidence.



Agilent Open

Agilent Open simplifies the process of connecting and programming test systems to help engineers design, validate and manufacture electronic products. Agilent offers open connectivity for a broad range of system-ready instruments, open industry software, PC-standard I/O and global support, which are combined to more easily integrate test system development.

"WiMAX," "Fixed WiMAX," "Mobile WiMAX," "WiMAX Forum," the WiMAX Forum logo, "WiMAX Forum Certified," and the WiMAX Forum Certified logo are trademarks of the WiMAX Forum. All other trademarks are the properties of their respective owners. cdma2000 is a registered certification mark of the Telecommunications Industry Association. Used under license.

Windows® and MSWindows® are U.S. registered trademarks of Microsoft Corporation. Bluetooth and the Bluetooth logos are trademarks owned by Bluetooth SIG, Inc., U.S.A. and licensed to Agilent Technologies.

Product specifications and descriptions in this document subject to change without notice.

© Agilent Technologies, Inc. 2002-2008

Printed in USA, May 6, 2008

5988-3935EN



Agilent Technologies