

Characterization of IQ Modulators Counts On Flexible Signal Generator Stimulus

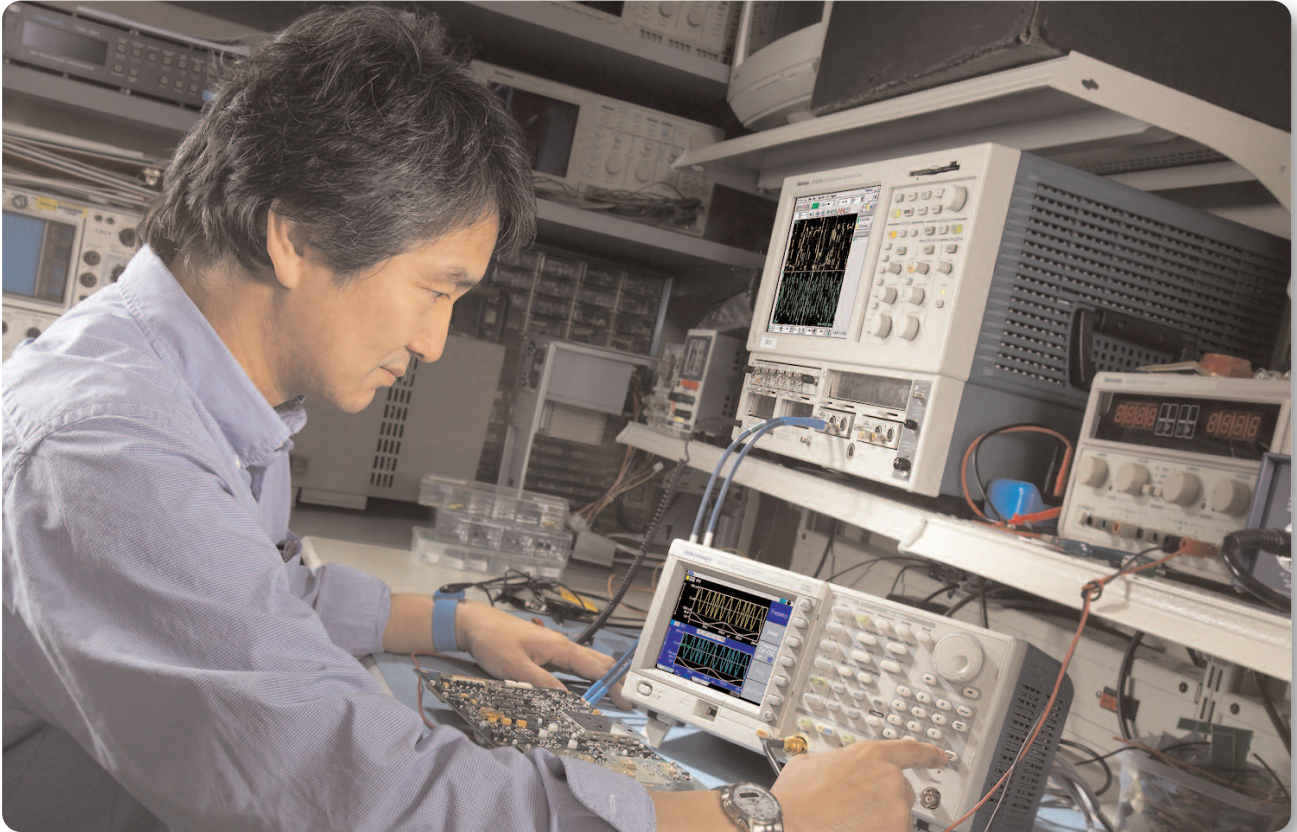

IQ modulators play a critical role in modern telecommunication. As demands for transmission bandwidth and signal quality continue to grow, suppliers of IQ modulators are working on new designs to address these requirements. During the design phase, the performance of new devices must be evaluated against a number of critical parameters.

This application note describes several of the important measurements design engineers routinely make on an IQ modulator. It illustrates how modern arbitrary/function generators provide a stimulus to characterize high performance IQ modulators thoroughly, with more flexibility and saving considerable time over previously used methods.

Characterization of IQ Modulators Counts On Flexible Signal Generator Stimulus

► Application Note

The Role of IQ Modulators in Mobile Telecommunication

Modern mobile telecommunication relies on quadrature amplitude modulation (QAM) to mix digital transmission data onto an RF carrier. In QAM, every logical state is assigned to a specific amplitude and phase value. An example for QAM is Quadrature Phase-Shift-Keying (QPSK) which encodes four possible symbol bit-pairs into phase shifts of a sine wave of $\pm 45^\circ$ and $\pm 135^\circ$ as shown in Figure 1. Higher order QAM makes it possible to transmit more bits per symbol. The most common forms are 16-QAM, 64-QAM, 128-QAM and 256-QAM.

Logic state	Amplitude	Phase
00	1	45°
01	1	135°
10	1	315°
11	1	225°

► Table 1. Amplitude and phase values in QPSK.

An efficient way to generate the modulating (baseband) signal with a specific amplitude and phase is to separate the signal vector into an in-phase "I" component with phase 0° and a quadrature "Q" component with phase 90° . This reduces the task to modulating the amplitudes of two sine wave signals. To illustrate, Table 2 lists the I and Q amplitudes corresponding to the four logical states for the QPSK example discussed here.

Logic state	I amplitude	Q amplitude
00	$+\sqrt{2}$	$+\sqrt{2}$
01	$-\sqrt{2}$	$+\sqrt{2}$
10	$+\sqrt{2}$	$-\sqrt{2}$
11	$-\sqrt{2}$	$-\sqrt{2}$

► Table 2. I and Q amplitudes in QPSK.

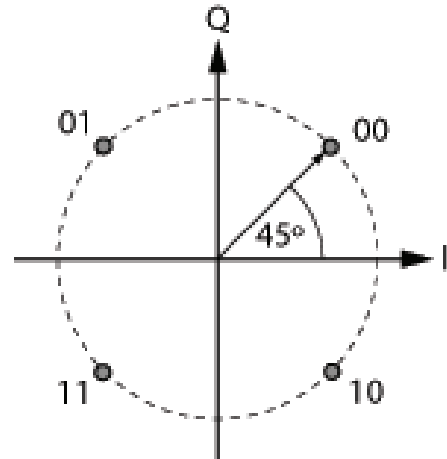

► Figure 1. Constellation diagram for QPSK.

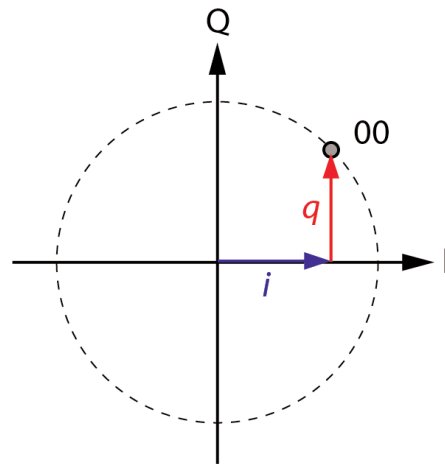

► Figure 2. I and Q vectors.

In a next step, the baseband signal is then modulated or up-converted onto the RF carrier with an IQ modulator. These modulators are available as integrated circuits from a number of semiconductor manufacturers. In principal, they consist of two multipliers that are each driven by the carrier or local oscillator (LO) frequency, one of them shifted by 90° against the other. The outputs of these multipliers are combined to the modulated RF vector signal.

Designers of IQ modulators are concerned that the devices meet certain performance criteria, such as modulation bandwidth, IQ amplitude balance, quadrature error, intermodulation distortion, local oscillator feedthrough, and others.

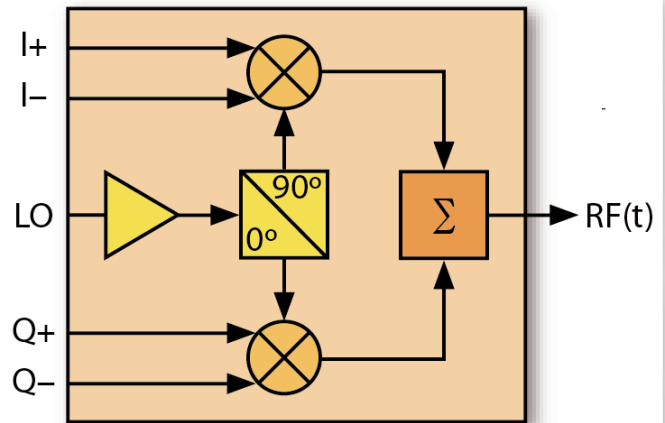

► **Figure 3.** IQ modulator block diagram.

Choosing an Appropriate Signal Generator

To characterize IQ modulators at the design stage, a dual channel signal generator is required to simulate the I and Q input signals. The instrument must allow the user to directly adjust amplitude and phase between I and Q signals with fine resolution. While a number of dedicated RF generators with integrated arbitrary waveform generators are available in the market, they commonly offer only limited flexibility for adjusting the signal parameters. In most cases, parameter changes require a modification of the data vector data via a software package and subsequent reloading of the vector into the signal generator. Making incremental adjustments thus becomes a tedious and time-consuming task.

Another limiting factor of these generators is their modulation bandwidth. IQ generators integrated into vector signal generators commonly feature bandwidths up to 40 or 100 MHz, which is insufficient for testing devices for modern broadband standards such as CDMA2000, GSM and WiMAX. Modern general purpose arbitrary/function generators (AFGs), on the other hand, offer bandwidths up to 240 MHz, and allow direct adjustment of all signal parameters with fine resolution.

The inputs of the IQ modulator require differential IQ signals, which are typically provided in modern communications systems by high-speed digital to analog converters (DACs). If a signal generator only has single-ended outputs, a single to differential converter circuitry is needed to create differential quadrature.

Common Measurements on an IQ Modulator

Before a new IQ modulator circuit design is released to the production line, it is thoroughly evaluated against target specifications. In addition, it is characterized with regard to all specifications to be published in the datasheet. The following describes typical measurements that designers of IQ modulators make when characterizing new designs, including bandwidth, carrier feed-through, sideband suppression, amplitude/phase mismatch and inter-modulation performance. These parameters are usually evaluated as a function of LO frequency and amplitude, baseband frequency and amplitude, as well as temperature.

Characterization of IQ Modulators Counts On Flexible Signal Generator Stimulus

► Application Note

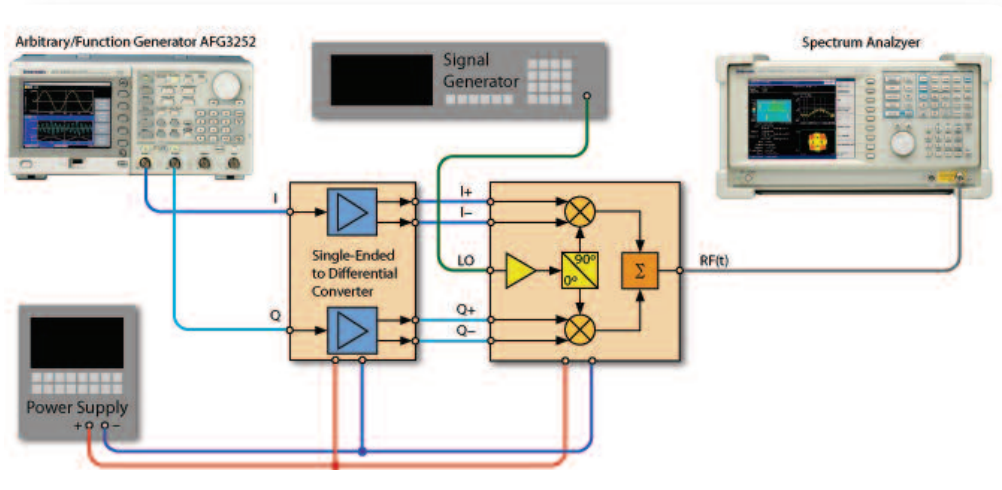

► **Figure 4.** Measurement set-up for IQ modulator characterization.

The test set-up for all the above measurements is shown in Figure 4. In this application, the I and Q signals are generated by a Tektronix AFG3252 arbitrary/function generator with dual single-ended signal outputs and a sine wave frequency range up to 240 MHz. The two channels can be programmed to generate completely independent signals. For this application, they are programmed to generate synchronous signals with identical frequency and adjustable amplitude and phase relationship. Aside from sine wave and numerous other standard waveforms, the instrument can also generate two-tone waveforms for inter-modulation distortion measurements. The specific settings of the AFG3252 will be discussed below in the sections that describe the different measurements.

Channels 1 and 2 of the AFG3252 generate the I and Q signals, respectively, and are connected to the corresponding inputs of the single-ended to differential converter circuit that feeds the IQ modulator. An RF signal generator provides the Local Oscillator frequency

of the IQ modulator. The output of the IQ modulator is being evaluated with an RF spectrum analyzer, a Tektronix RSA3408A, with a frequency bandwidth of 8 GHz and exclusive frequency mask trigger for event-based capture of transient RF signals.

Measuring Modulation Bandwidth

This test determines the maximum modulation frequency that the IQ modulator supports. Datasheets for IQ modulators often provide the "0.1 dB" and "1 dB" points, i.e. the frequencies where the power level of the desired sideband is reduced by the stated level.

During this test, the AFG3252 arbitrary/function generator generates the I and Q signal inputs that will – after conversion from single-ended to differential – serve as input to the IQ modulator under test. While the IQ signal frequency $f_{\text{modulation}}$ is varied from 1 to 240 MHz, the power level of the IQ modulator output is measured on the spectrum analyzer at the desired sideband frequency $f_{\text{carrier}} + f_{\text{modulation}}$.

Programming the AFG3252 for this task is straightforward. Channels 1 and 2 are programmed to generate standard sine waves with identical frequencies and amplitude and a constant phase offset of 90° between channels 1 and 2. All parameter settings are summarized in Table 3. These settings couple the frequency and amplitude settings in channels 1 and 2, and program a constant phase offset of 90° between both channels.

Parameters	Setting
Channels 1 / 2 - Run Mode	Continuous
Channels 1 / 2 - Function	Sine
Frequency: Frequency CH1=CH2	0n
Amplitude: Level CH1=CH2	0n
Amplitude	0.5 Vpp
Frequency	1 MHz
Channel 2: Phase	90°

► **Table 3.** AFG3252 settings for modulation bandwidth measurement.

While you program the instrument, its large display shows the available selections and related settings along with a graphical representation of the configured waveform. At a single glance, this provides full confidence that all settings are entered correctly. (Figure 5).

After both channels of the AFG3252 are programmed, select the dual channel display by pressing the "View" button. This now shows graphically the selected amplitudes, frequencies and phase relationship for channel 1 and 2 (Figure 6).

After all the connections are made between the arbitrary/function generator, local oscillator, IQ modulator and spectrum analyzer according to Figure 4, turn the signal outputs of the AFG3252 on.

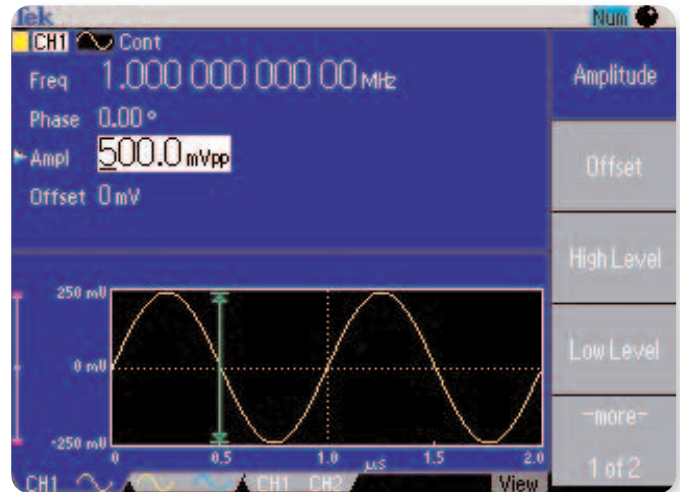

► **Figure 5.** AFG3252 display with channel 1 settings for bandwidth measurement.

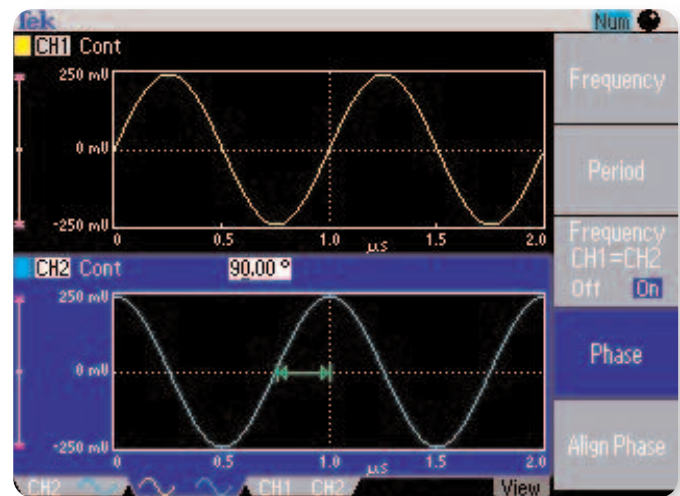

► **Figure 6.** Display of the AFG3252 for the IQ Modulator bandwidth measurement.

Characterization of IQ Modulators Counts On Flexible Signal Generator Stimulus

► Application Note

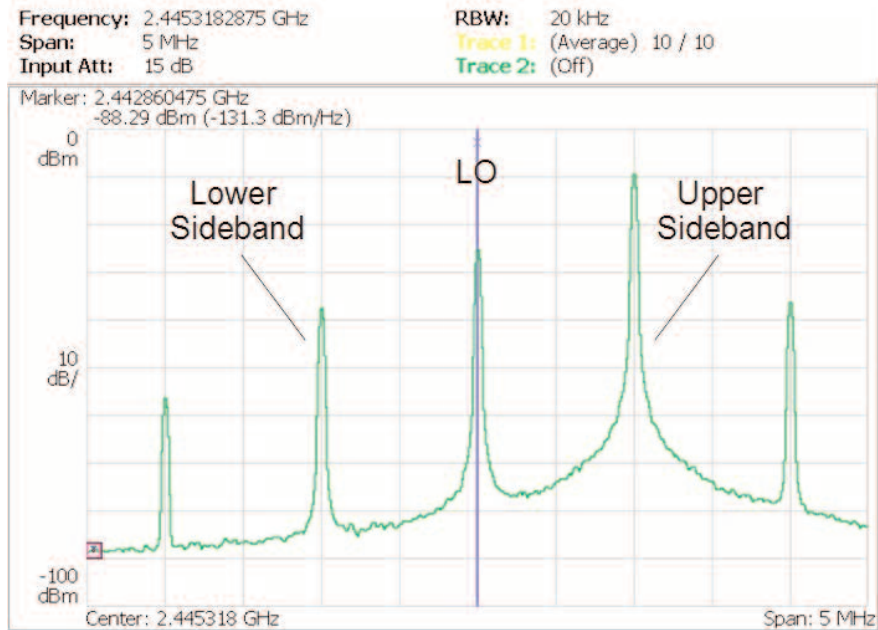

► **Figure 7.** Spectrum Analyzer display with LO frequency, lower and upper sideband.

Now center the spectrum analyzer display on the LO frequency. Next, move the desired sideband to the center of the screen and read the power level. In the example here, the LO frequency is set to 2.44 GHz and the upper sideband is the desired one. Then incrementally increase the frequency of the IQ signal while measuring and recording the power level of the desired sideband. To move through the spectrum speedily, increase the frequency in logarithmic steps: 1, 2, 5, 10, 20, ...

Since the AFG3252 is based on DDS (Direct Digital Synthesis), it is necessary to realign the signal phase between channels 1 and 2 after each frequency increase. This can be done by pressing the "Frequency" button and selecting "AlignPhase" on the screen menu. If a PC is available with instrument control software such as LabView or National Instruments Signal Express, the signal generator can be stepped automatically through the desired frequency band with phase alignment after each incremental change.

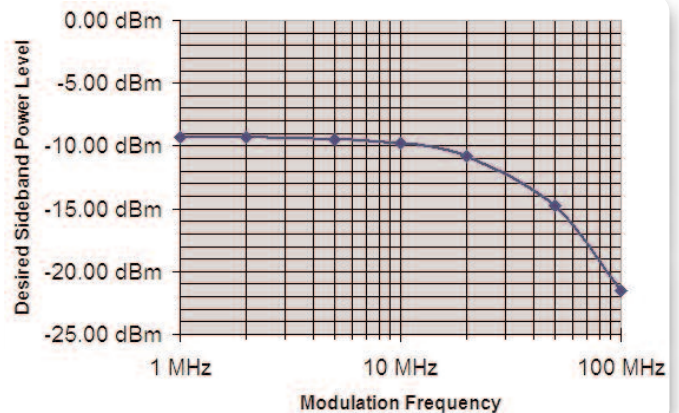

► **Figure 8.** Measurement results for IQ modulator bandwidth measurement.

The measurement results are shown in Figure 8 above. The plot shows a 0.1 dB bandwidth of about 1.5 MHz, and a 1 dB bandwidth of about 15 MHz.

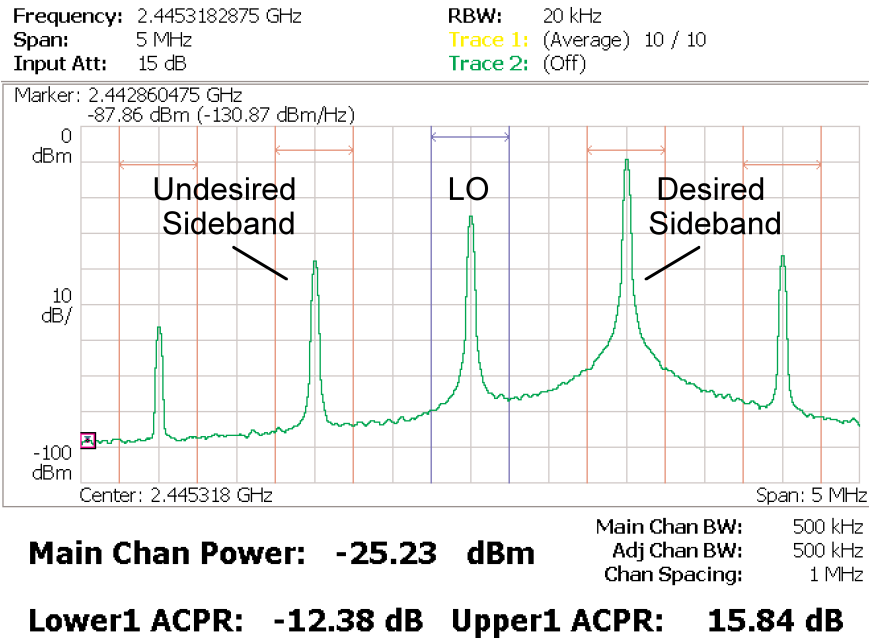

► **Figure 9.** LO leakage and undesired sideband leakage of the IQ modulator.

Carrier Feedthrough and Sideband Suppression

To assure high signal quality, the ideal IQ modulator would have perfectly symmetrical in-phase and quadrature arms. While developers strive for a symmetrical IQ modulator circuit, manufacturing process variations cause slight differences between the in-phase and quadrature paths on the same die. These imbalances cause the carrier tone and undesired sideband to bleed into the output signal and degrade the RF spectrum. If the leakage is large, it could potentially desensitize the receiver and impact its capability to decode the demodulated IQ signal properly.

To provide engineers who use IQ modulators with the required data points, designers of IQ modulators need to measure carrier feed-through and sideband suppression on the bench and specify them in the datasheet. Connect the measurement equipment and IQ modulator as described in Figure 4 and configure the AFG3252 with the parameters in Table 3. Now measure the power levels at LO frequency and undesired

sideband frequency relative to the power level of the desired sideband. As reflected in Figure 9, the IQ modulator under consideration here has a carrier feed-through of -25.2 dBm and a sideband suppression of -28.2 dBc with reference to the desired sideband at a modulating frequency of 1 MHz and input voltages of 500 mVpp.

Measuring IQ Amplitude Imbalance and Quadrature Error

As discussed in the previous section, amplitude imbalance and phase error between in-phase and quadrature arms of an IQ modulator result in carrier feed-through and undesired sideband leakage. The relationship between the modulator imbalances, sideband suppression and LO leakage can be calculated mathematically. LO leakage is caused by minute DC offsets between the differential baseband inputs and independent of the quadrature error. The undesired sideband leakage is dependent on both, amplitude imbalance and quadrature error.

Characterization of IQ Modulators Counts On Flexible Signal Generator Stimulus

► Application Note

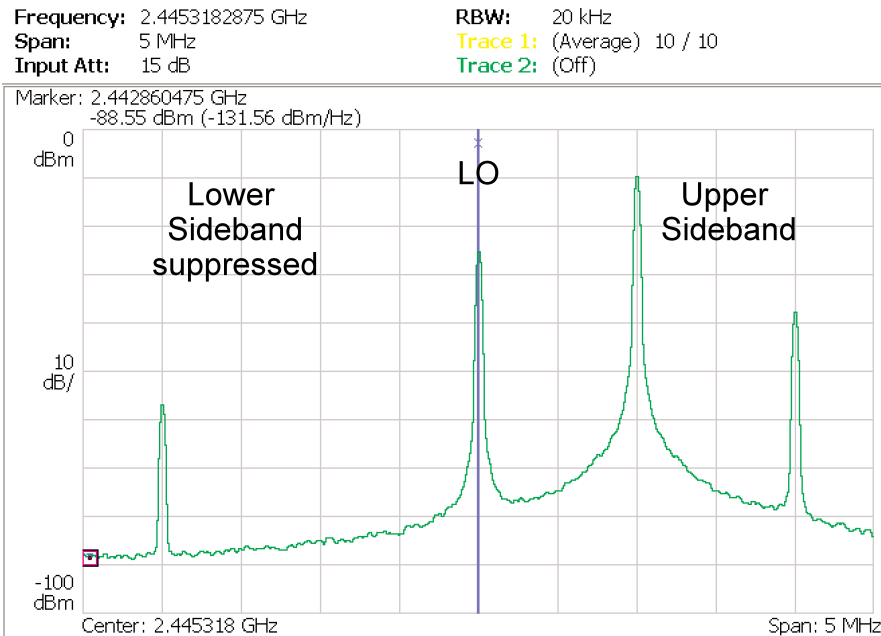

► **Figure 10.** Sideband Suppression Nulling.

Engineers who use IQ modulators to build transmission systems need to understand these parameters. This allows them to determine the suitability of the device for the intended application and the need for any external compensation of amplitude and phase errors.

To measure the amplitude imbalance and quadrature error, we can make use of the fact that the sideband suppression can be optimized by adjusting phase and amplitude offsets between I and Q channel. When only one parameter is adjusted, sideband suppression asymptotically approaches a limit. Therefore, gain and phase need to be adjusted consecutively in several steps until the undesired sideband leakage is minimized. The opposite values of the Q channel adjustments then reflect the mismatch inherent to the modulator.

The measurement setup is again as shown in Figure 4. The arbitrary/function generator provides the signal input to the IQ modulator. Initially, it is configured as for the bandwidth measurements (Table 3).

To determine the DC offsets of the differential baseband inputs, adjust the DC bias on the single-ended to differential converter circuit until the IQ modulator output power at the LO frequency is minimized.

To determine the IQ modulator's gain and phase errors, observe the undesired sideband power on the spectrum analyzer while holding amplitude and phase of the AFG3252's channel 1 (I signal) constant and making iterative adjustments to amplitude and phase of channel 2 (Q signal) until the sideband power level is minimized (Figure 10). Unlike vector signal generators with built-in IQ generators that require reloading of the signal vector for parametric adjustments, the AFG3252 allows direct adjustment of phase and amplitude via the rotary knob on the front panel, with an amplitude resolution of 0.1 mV and a phase resolution of 0.01.

As it turns out, the sideband on the IQ modulator, used as an example here, could be suppressed by reducing the amplitude in channel 2 from 500 mV to 461.8 mV and the phase from 90° to 89.79°. Accordingly, the IQ amplitude imbalance is 0.0764 or 0.35 dB and the quadrature error 0.21°.

Inter-modulation Distortion

When two or more tones interact in amplifiers, modulators or other electronic devices, they produce multiple intermodulation products. This effect is referred to as intermodulation distortion (IMD) and caused by non-linearities of the device. In RF communication, this presents a problem as it widens the signal spectrum, interferes with the transmission signal, and reduces the dynamic range of wireless transceivers.

The frequencies of the intermodulation products are the sum and difference of integer multiples of the original tones. This can be expressed mathematically as

$$m \cdot f_1 \pm n \cdot f_2 \quad m, n \text{ are integers}$$

The sum of $m + n$ is referred to as order of the intermodulation products. The second and third order inter-modulation products are critical. The second order intermodulation products $f_1 + f_2$, $2 \cdot f_1$, $2 \cdot f_2$ and $f_1 - f_2$ are far enough from the desired signals so that they can be removed easily with filters. The third order intermodulation products $2 \cdot f_1 - f_2$ and $2 \cdot f_2 - f_1$ often present a problem because they are in-band, close to

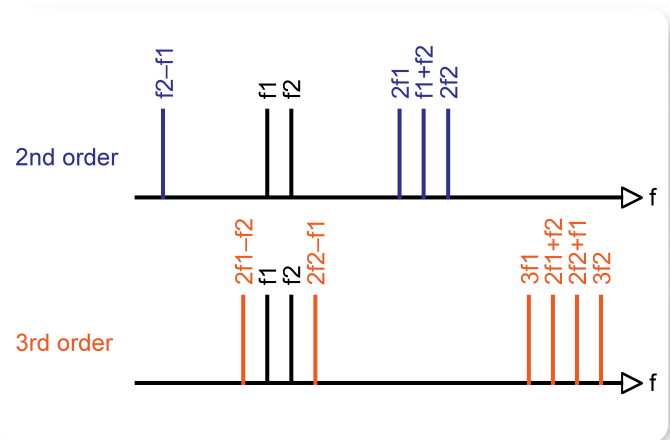

► **Figure 11.** Distribution of 2nd and 3rd order intermodulation products.

the desired signals and therefore difficult to filter out. Other third order and higher order products are less important, because they are more widely spaced and at a smaller level.

Manufacturers of IQ modulators typically specify second and third order distortion relative to the per tone level of the desired signals. To measure these parameters, we use again the measurement setup as described in Figure 4. Unlike in the previous measurements, the signal generator now needs to generate in each channel two tones of different frequencies, with an offset of 90 degrees in between the channels. To accomplish this, we utilize the arbitrary waveform capability of the AFG3252.

Characterization of IQ Modulators Counts On Flexible Signal Generator Stimulus

► Application Note

As explained in the sidebar *Creating Dual Tone Waveforms with ArbExpress®* on page 13, the dual tone arbitrary waveforms can be defined conveniently via the waveform math function of the PC software package ArbExpress®. In this example, the AFG3252 is programmed to generate dual tones at 3.5 MHz and 4.5 MHz. After the waveform files are created, they can be transferred via a USB memory device to the arbitrary/function generator: Plug the USB memory with the waveform files into the front panel USB port of the AFG3252. Press the button "Edit", select "Read from..." from the screen menu, then "USB", and select the file for channel 1 from the list on the screen. Next, select "more" from the screen menu, then "Write to..." and load the arbitrary waveform into the memory User1 of the instrument. Now, follow the same steps to load and save the arbitrary waveform into the memory User2 of the instrument. Lastly, program the AFG3252 with the settings as shown in Table 4.

Parameters	Setting
Channels 1 / 2 - Run Mode	Continuous
Channels 1 / 2 - Function	Arb
Channel 1 - Arb Waveform Menu	User1
Channel 2 - Arb Waveform Menu	User2
Frequency: Frequency CH1=CH2	0n
Amplitude: Level CH1=CH2	0n
Amplitude	0.5 Vpp
Frequency	500 kHz

► **Table 4.** AFG3252 settings for inter-modulation distortion measurement.

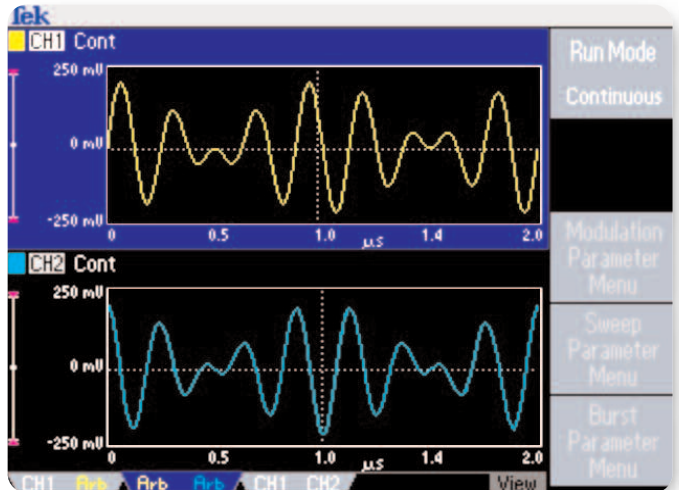

► **Figure 12.** AFG3252 display programmed to generate dual tones.

Note in Figure 12 that the waveshapes in channel 1 and 2 are different from one another. To generate the dual tone in quadrature, the channel 2 signal was created with an offset of 90° for each of the single tones, before they were added together with waveform math.

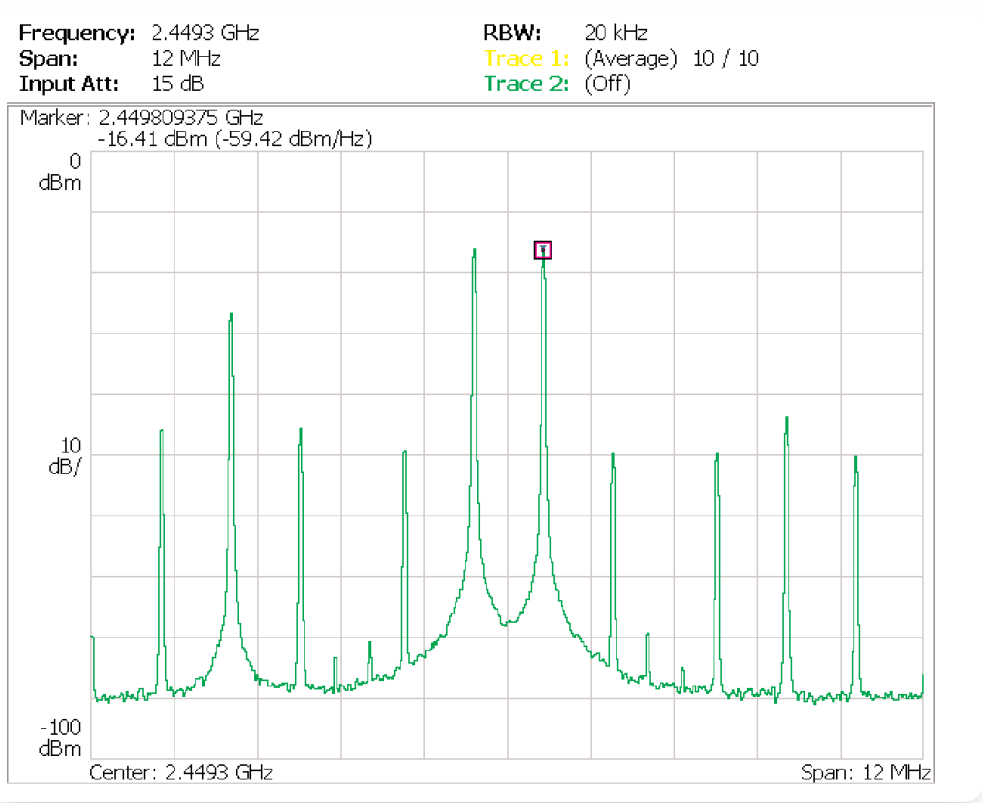

► **Figure 13.** Spectrum analyzer measurement of inter-modulation distortion.

Conventional measures for quantifying device linearity are the output intercept points (OIP). These are defined by the formula

$$OIP_n = P_{out} + \frac{R_n}{n - 1}$$

where P_{out} is the power of the strongest intended tone, R_n is the suppression of the inter-modulation products relative to the power of the reference tone, and n is the order of the inter-modulation product. Figure 13 shows the spectrum analyzer measurement for the 3.5 MHz and 4.5 MHz dual tones centered at the upper sideband of the LO frequency. From the measured reference tone level of -16.4 dBm, second order product of -43.4 dBm and third order product of -49.8 dBm, OIP2 and OIP3 can be calculated as 10.6 dBm and

0.3 dBm, respectively.

An important point to consider for IMD measurements is that the signal generator generates IMD of its own due to non-linearity in the output stage. The measured IMD (MIMD) at the device output is the vector sum of SIMD and device IMD. Depending on the phase between the two of them, they may be additive or partially cancel each other out. The maximum positive error (the voltages are in phase) is:

$$err_+ = 20 \log \left(1 + 10^{\frac{SIMD - MIMD}{20}} \right)$$

When the voltages are out of phase, the maximum negative error is:

$$err_- = 20 \log \left(1 - 10^{\frac{SIMD - MIMD}{20}} \right)$$

Characterization of IQ Modulators Counts On Flexible Signal Generator Stimulus

► Application Note

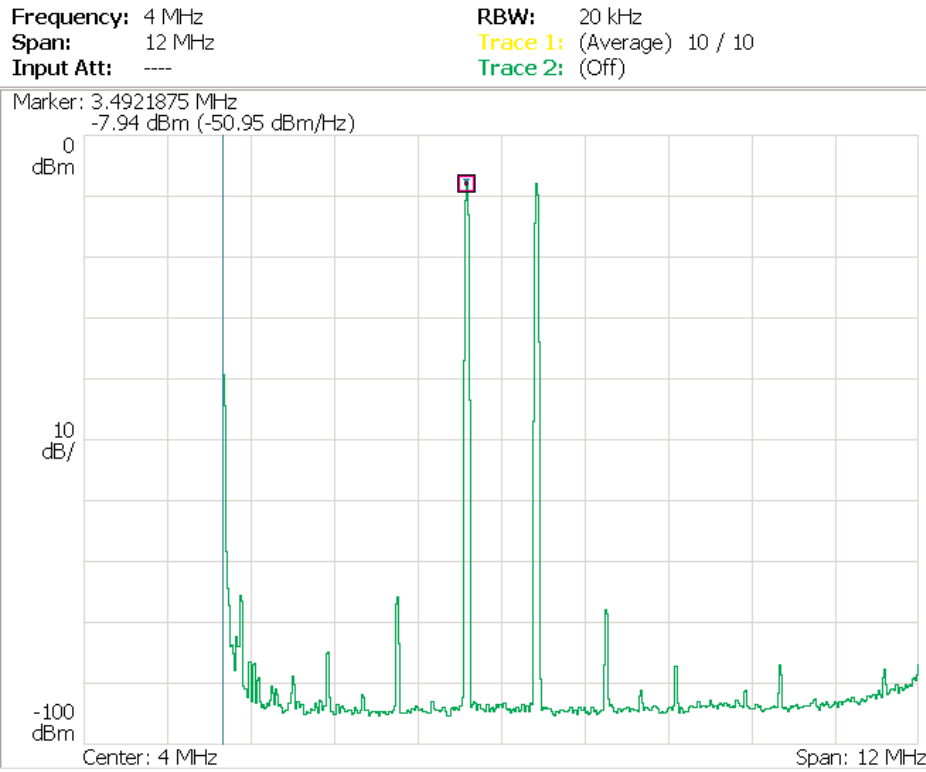

► **Figure 14.** Spectrum analyzer measurement of the source IMD.

Figure 14 shows the measured source IMD at the AFG3252 output. The second-order SIMD is -78.8 dBc and the third-order SIMD is -69.9 dBc. This implies that

the measured second-order IMD of -27 dBc has an error of ± 0.02 dB, and the measured third-order IMD of -33.4 dBc an error of ± 0.13 dB.

Creating Dual Tone Waveforms with ArbExpress®

Powerful PC software tools for waveform creation and editing provide engineers with a variety of convenient techniques to create exactly the wave shape required by their application.

The best way to create dual tones for inter-modulation distortion measurements on an IQ modulator is via waveform math. In this approach, the sine waves for the two tones are created separately with the desired amplitude and frequency and then added mathematically.

The arbitrary waveform generator stores and generates the defined waveform as discrete samples. The finest timing resolution is achieved when the instrument

operates at the highest sampling rate. The arbitrary/function generator AFG3252 operates at a sampling rate of 2 GS/s, outputting one sample every 0.5 ns, for waveform lengths up to 16K. Accordingly, the dual tone waveforms should be defined with a length of 16,384 points.

To avoid discontinuities when the generator loops from the end of the waveform in memory back to its beginning, care must be taken when defining the number of cycles for each tone. The correct number of cycles can be determined by finding the smallest integer values m and n that satisfy the equation

$$m, n = \text{integer} \quad \frac{m}{n} = \frac{f_1}{f_2}$$

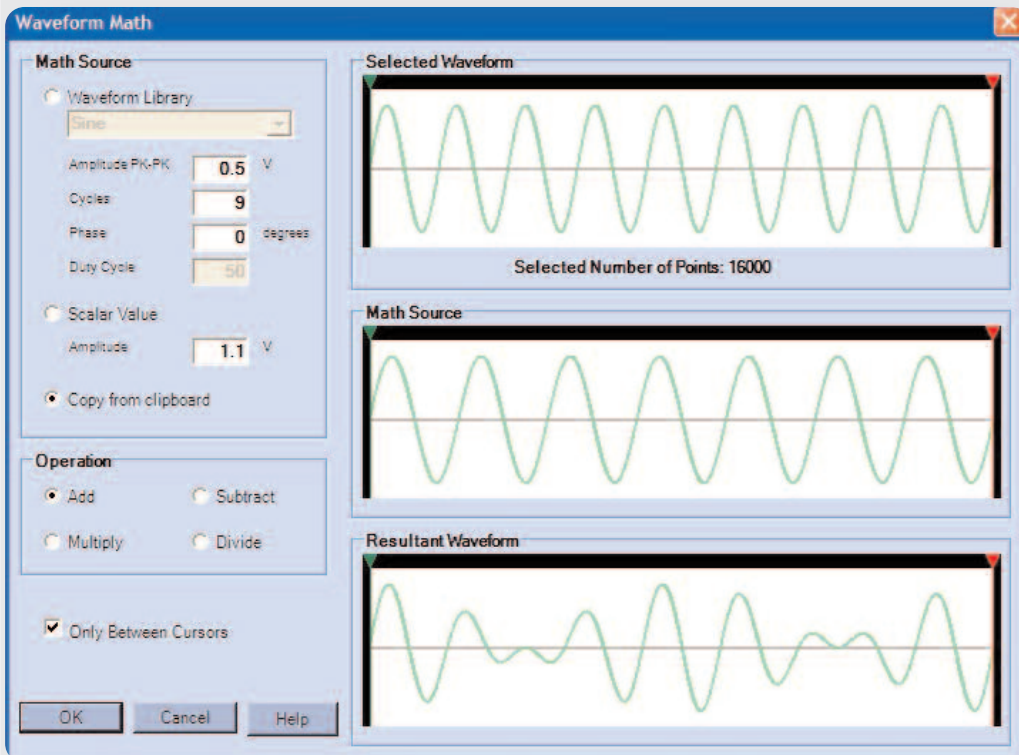

▶ **Figure 15.** Creating dual tones with ArbExpress software.

A seamless transition from waveform end to start is assured, when f_1 is defined with m cycles and f_2 with n cycles. Using the example of $f_1 = 3.5$ MHz and $f_2 = 4.5$ MHz from the section "Intermodulation Distortion" in this note, the correct values are $m = 7$ and $n = 9$. Figure 15 shows the corresponding waveform math window in ArbExpress.

For an arbitrary waveform generator based on direct digital synthesis architecture, such as the AFG3252, the frequency setting reflects the rate at which the

waveform in memory is played back. Considering that the desired dual tone waveform is stored in memory with multiple waveform cycles, the frequency on the instrument must be set to a lower value than the desired output frequency. The correct setting can be calculated from

$$f_{\text{arb}} = \frac{f_1}{m} = \frac{f_2}{n}$$

For the 3.5 MHz and 4.5 MHz defined in 7 and 9 cycles, respectively, the setting turns out to be $f_{\text{arb}} = 500$ kHz.

Characterization of IQ Modulators Counts On Flexible Signal Generator Stimulus

► Application Note

Conclusion

As these measurement examples illustrate, the performance and flexibility of modern arbitrary/function generators enables design engineers to thoroughly characterize IQ modulators. Directly and finely adjustable waveform parameters such as amplitude, frequency and phase save much time over other arbitrary waveform generators that require time consuming reloading of signal vectors to change any parameters.

Nonetheless, designers of IQ modulators also need to make other measurements that require stimuli at RF or IF frequencies, digital modulation, the simulation of complex protocols, or real-world behaviors. For these, high-end arbitrary waveform generators with high bandwidths and sequencing capabilities still remain the tool of choice.

Contact Tektronix:

ASEAN / Australasia (65) 6356 3900
Austria +41 52 675 3777
Balkan, Israel, South Africa and other ISE Countries +41 52 675 3777
Belgium 07 81 60166
Brazil & South America (11) 40669400
Canada 1 (800) 661-5625
Central East Europe, Ukraine and the Baltics +41 52 675 3777
Central Europe & Greece +41 52 675 3777
Denmark +45 80 88 1401
Finland +41 52 675 3777
France +33 (0) 1 69 86 81 81
Germany +49 (221) 94 77 400
Hong Kong (852) 2585-6688
India (91) 80-22275577
Italy +39 (02) 25086 1
Japan 81 (3) 6714-3010
Luxembourg +44 (0) 1344 392400
Mexico, Central America & Caribbean 52 (55) 5424700
Middle East, Asia and North Africa +41 52 675 3777
The Netherlands 090 02 021797
Norway 800 16098
People's Republic of China 86 (10) 6235 1230
Poland +41 52 675 3777
Portugal 80 08 12370
Republic of Korea 82 (2) 528-5299
Russia & CIS +7 (495) 7484900
South Africa +27 11 254 8360
Spain (+34) 901 988 054
Sweden 020 08 80371
Switzerland +41 52 675 3777
Taiwan 886 (2) 2722-9622
United Kingdom & Eire +44 (0) 1344 392400
USA 1 (800) 426-2200

For other areas contact Tektronix, Inc. at: 1 (503) 627-7111
Updated 15 September 2006

Our most up-to-date product information is available at: www.tektronix.com



Copyright © 2007, Tektronix. All rights reserved. Tektronix products are covered by U.S. and foreign patents, issued and pending. Information in this publication supersedes that in all previously published material. Specification and price change privileges reserved. TEKTRONIX and TEK are registered trademarks of Tektronix, Inc. All other trade names referenced are the service marks, trademarks or registered trademarks of their respective companies.

4/07 FLG/WOW

75W-20744-0

Tektronix
Enabling Innovation

